

**deli**

**Рекламные материалы и оборудование**

Москва 2020

# Содержание

- *Общие материалы*
- *Офис*
- *Школа*
- *Клеящие*
- *Пишущие*
- *Материалы для мероприятий*

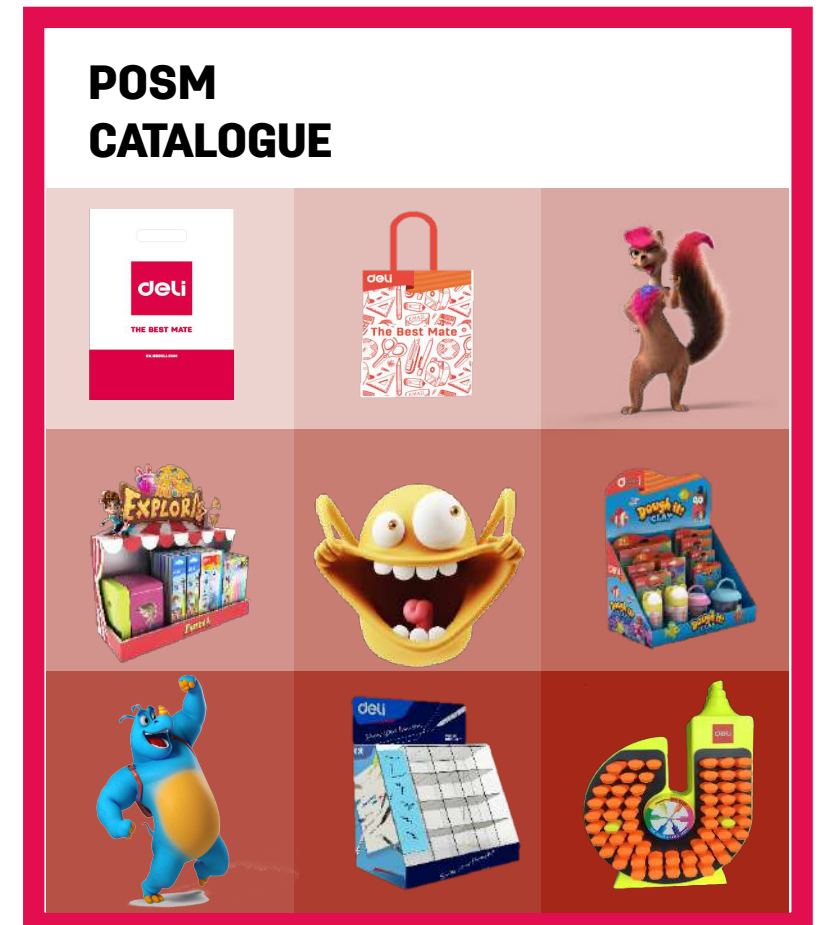

# Общие материалы

# Ad. Mug

## ■ Ad. Mug Specification

- **Reference: W10016**
- Size :12.5cm\*6.7cm (cup bottom) \*8.2cm (cup top)
- Packing: 24 PCS/ CASE
- Material: Ceramics
- G.W.: 9 KG
- Logistic : 0.04 ( box meas.:37\*35\*28CM)



# T-SHIRT white/red

**deli**  
OFFICE

## ■ T-SHIRT white/red Specification

Reference	Logistic	N.W./G.W.
▪ <b>W10057 XL (white)</b>	0.05m <sup>3</sup> ( box meas.: 50*35*27 cm)	10.7/11.3 KG
▪ <b>W10059 M (red)</b>	0.04m <sup>3</sup> ( box meas.: 42*34*27 cm)	9.8/10.4 KG
▪ <b>W10060 L (red)</b>	0.05m <sup>3</sup> ( box meas.: 50*35*27 cm)	10.2/10.8 KG
▪ <b>W10061 XL (red)</b>	0.04m <sup>3</sup> ( box meas.: 42*34*27 cm)	10.7/11.3 KG
▪ Packing: 36 PCS/ CASE		
▪ Material: Cotton		

**WHITE T-SHIRT CANCEL  
AFTER OUT OF STOCK**



# Ad. Hat white/red

## ■ Ad. Hat white/red Specification

- **Reference: W10013-RED**
- Packing: 48 PCS/ CASE
- G.W.: 5 KG
- Logistic : 0.05m<sup>3</sup> ( box meas.: 40\*32\*38 cm)



# Plastic Bag ( Large )

## ■ Plastic Bag ( Large ) Specification

- **Reference: W10010**
- Color: Red
- Size: 37cm\*55.5cm
- Packing: 1000 PCS/ CASE
- N.W.: 36.5 KG
- G.W.: 37.5 KG
- Logistic : 0.05m<sup>3</sup>( box meas.: 41.5\*39\*31.5 cm)



# Plastic Bag ( Small )

## ■ Plastic Bag ( Small ) Specification

- **Reference: W10036**
- Color: Red
- Size: 29.5cm\*43cm
- Packing: 1000 PCS/ CASE
- G.W.: 24 KG
- Logistic : 0.03m<sup>3</sup>( box meas.: 33.5\*32\*32 cm)

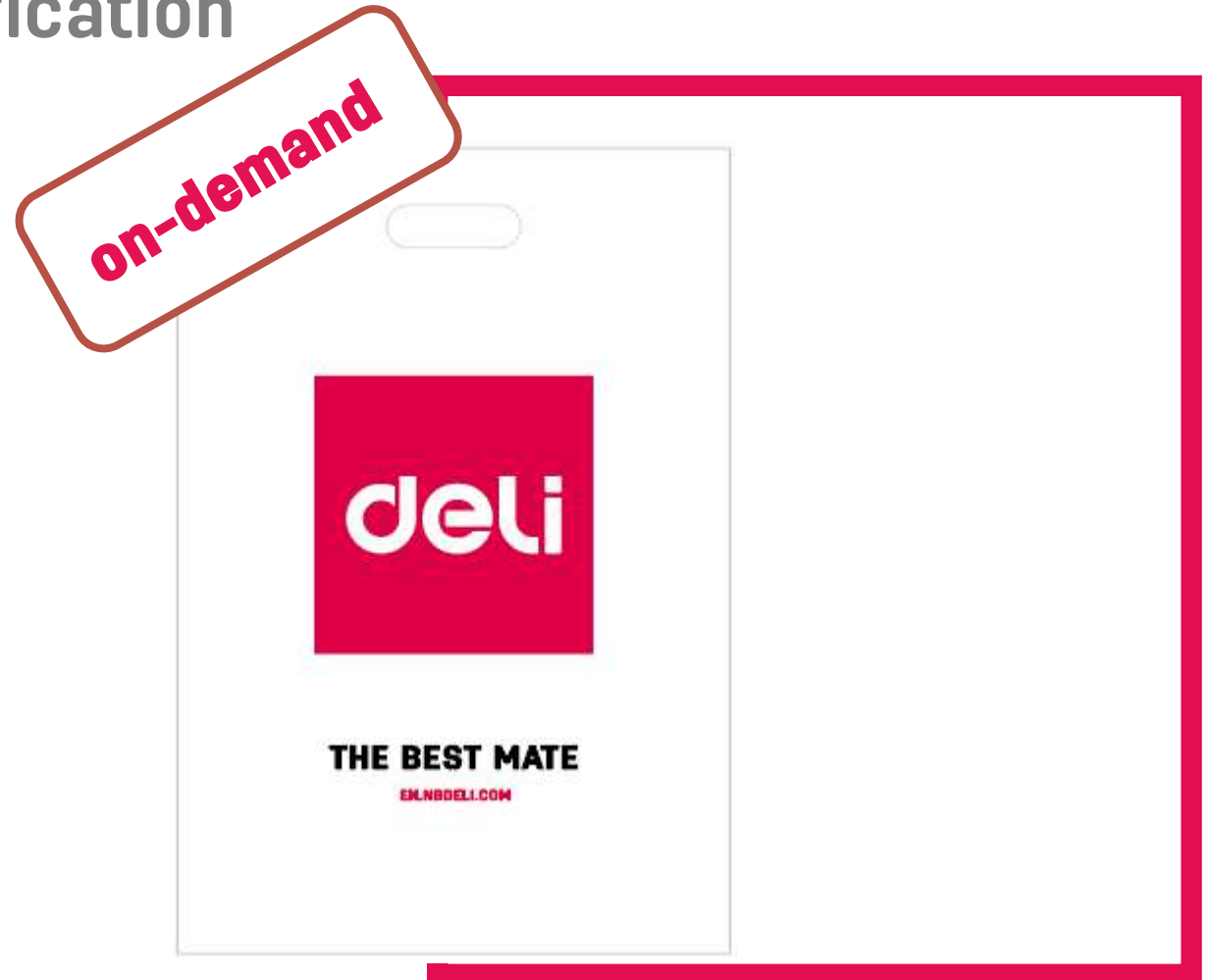



# DELI ADVERTISING TAPE

## ■ Deli Advertising Tape Specification

- **Reference: W10034**
- Size : 3mm\*76mm\*1200mm
- Packing: (34Pcs+1Tape Sealer 802) / CASE
- Logistic : 0.03m<sup>3</sup> ( box meas.: 36.5\*24.5\*37.5 cm)
  
- N.W.:13.1 kgs
- G.W.:13.7 kgs



# Gift bag-office

## ■ Gift bag-office

- **Reference: J00360**
- Size : 30\*10\*40cm
- Material : paper
- Logistic : 0.021m<sup>3</sup> ( box meas.:42\*30\*17 cm)
- Packing: 100PCS / CASE
- G.W: 5.94kg



# Gift bag-school

## ■ Gift bag-school

- **Reference: J00361**
- Size : 30\*10\*40cm
- Material : paper
- Logistic : 0.024m<sup>3</sup> ( box meas.: 40\*30\*20 cm)
- Packing: 100PCS / CASE
- G.W: 6.08kg



**Офис**

# OPP BAG UNIVERSAL S

## ■ Opp Bag Universal S Specification

- **Reference: J00153A**
- Size:  $(40+3+180)*52\text{mm}$
- Packing: 200 PCS/ Package
- G.W.: 0.25 KG
- Logistic :  $0.0006\text{m}^3$ ( package meas.:  $5.5*26.5*4.5\text{ cm}$ )

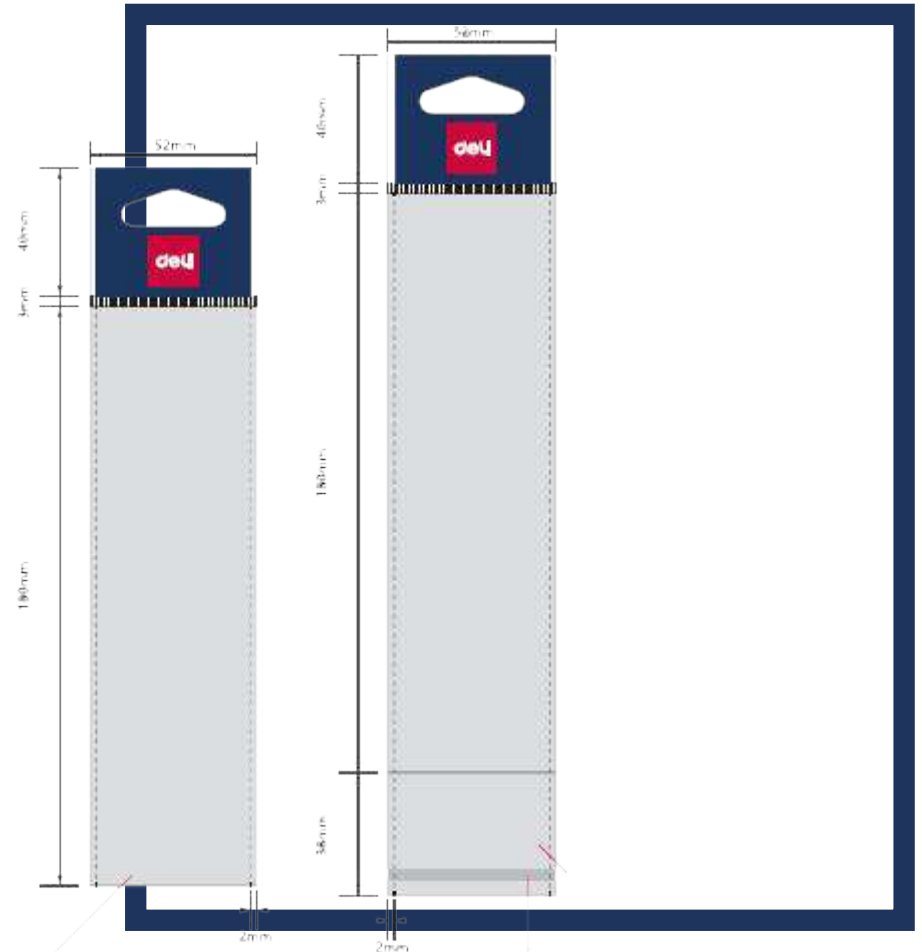

# OPP BAG UNIVERSAL M

## ■ Opp Bag Universal M Specification

- **Reference: J00154A**
- Size: (40+3+180)\*84mm
- Packing: 200 PCS/ Package
- G.W: 0.39 KG
- Logistic : 0.0009m<sup>3</sup>( package meas.: 9\*26.5\*4 cm)

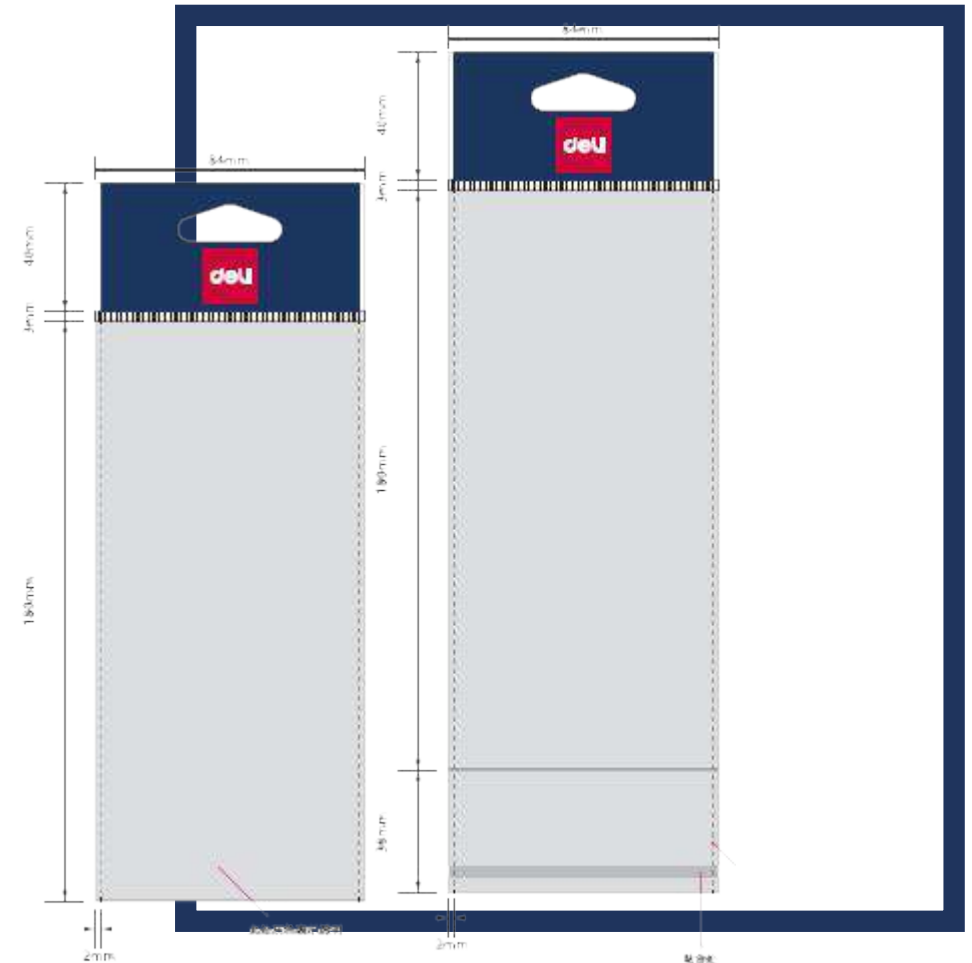

# OPP BAG UNIVERSAL L

## ■ Opp Bag Universal L Specification

- **Reference: J00155A**
- Size: (40+3+180)\*144mm
- Packing: 200 PCS/ Package
- G.W: 0.71 KG
- Logistic : 0.0016m<sup>3</sup>( package meas.: 14.5\*28\*4 cm)

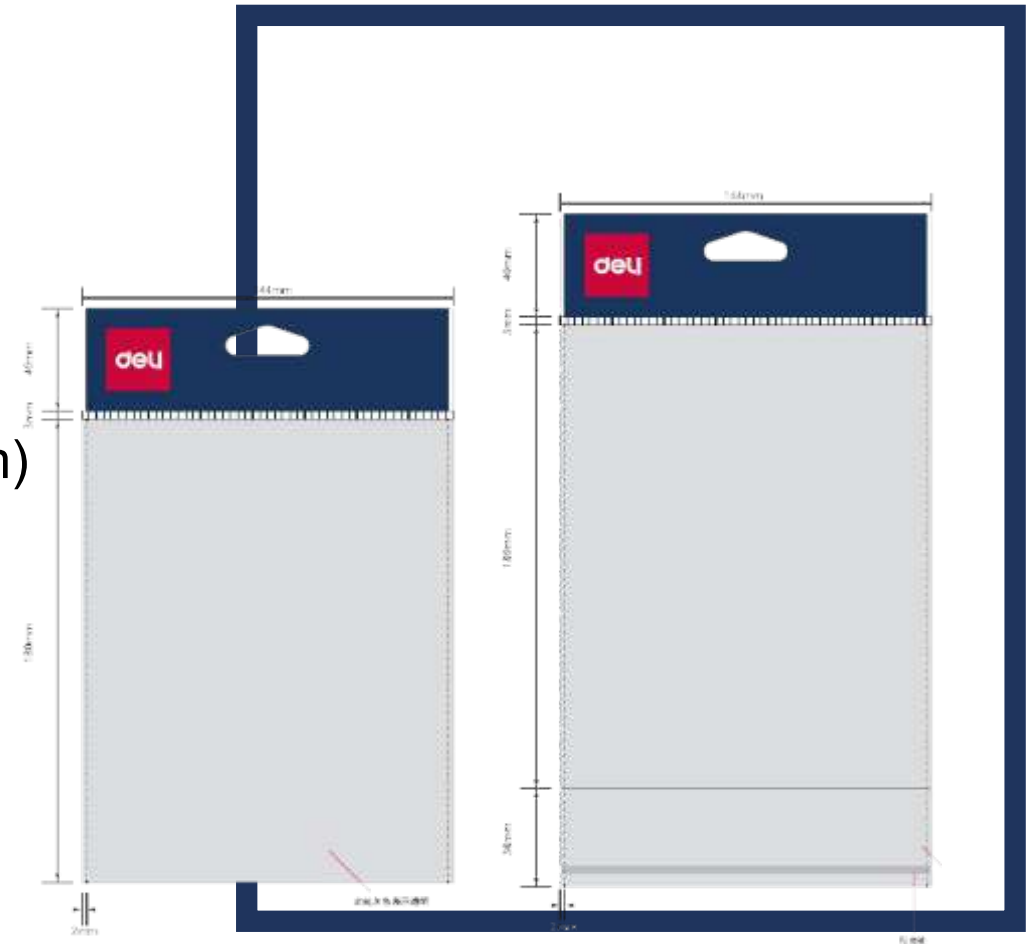

# Transversal Office Display

## ■ Transversal Office Display Specification

- **Reference: J00070**
- Size : 2m x 40cm x 60cm.
- Number of hooks : 40 without label holder
- Number of shelves : 2 can be removed
- Material : Steel Metal
- Marking

*Silk screening on base.*

*Printed KT-board on sides ( can be replaced )*

*Printed Soft PP board on banner ( can be replaced )*

- N.W.: 18.7 KG
- G.W.: 21.5 KG
- Logistic : 0.15m<sup>3</sup> ( 2 box of 0.076m<sup>3</sup> & 0.073m<sup>3</sup> )
- Palletized





# 1.5M Office Metal Display

**deli**  
OFFICE

## ■ 1.5M Office Metal Display Specification

- **Reference: J00192**
- Size : 40\*50\*150cm
- Number of hooks : 20 without label holder
- Number of shelves : 2 can be removed
- Material : Steel Metal
- Marking  
*Printed KT-board on side ( can be replaced )*
- N.W.: 15.7 KG
- G.W.: 17.8 KG
- Logistic : 0.15m<sup>3</sup> ( 2 box of 0.03m<sup>3</sup> & 0.12m<sup>3</sup> )



# Calculator stand display

## ■ Calculator stand Display Specification

- **Reference: J00333**
- Size : 60\*35\*190
- Number of hooks : 20 without label holder
- Number of shelves : 2 can be removed
- Material : Steel Metal
- N.W: A: 6.5KG B: 15.7KG
- G.W: A: 9.5KG B: 19.5KG
- Logistic : A: 0.049m<sup>3</sup> B: 0.094m<sup>3</sup>



# Calculator Display

## ■ Calculator Display Specification

- **Reference: J00182**
- Size : 50cm\*40cm\*175cm
- Number of hooks : 10  
*(Groove plate design, hooks can move flexibly, adapt to different sizes of products)*
- Number of shelves : 3
- Material :Wood
- Packing:1 PCS / CASE
- N.W: 19.2 KG
- G.W: 21.9 KG
- Logistic : 0.17m<sup>3</sup> ( 2 box of 0.09m<sup>3</sup> & 0.08m<sup>3</sup> )



# Cutter & Scissors Display

## ■ Cutter & Scissors Display Specification

- **Reference: J00190**
- Size : 17.5\*39.5\*62cm
- Number of Hooks : 10 without label holder
- Usage Scenarios : Desktop & Hanging on the Wall
- Material : Metal
- N.W: 3.4 KG
- G.W: 3.7 KG
- Logistic :0.01m<sup>3</sup> ( box meas.: 5.5\*40\*63 cm)



# Highlighter Display

## ■ Highlighter Display Specification

- **Reference: J00125**
- Size : 32.5cm x 13cm x 45cm.
- Number of Pen Slots : 60 PCS
- Material : Vacuum Plastic
- Marking

*Silk screening deli logo.*

*Printed communication in the middle*

- Logistic : 0.03m<sup>3</sup> ( box meas.: 49\*36\*16 cm)
- Packing: 1 PCS/ CASE
- N.W.:1.8 KG
- G.W.:2.2 KG



# Writing Tools Display

## ■ Writing Tools Display Specification

- **Reference: J00206**
- Size : 140\*400\*200mm
- *Independent parts can be linked together by magnetic strips*
- Material :Acrylic
- Packing: 1 SET/ CASE
- N.W.: 2.1 KG
- G.W: 2.5 KG
- Logistic :0.07m<sup>3</sup> ( box meas.: 55\*27\*47 cm)





# Школа



# School OPP BAG UNIVERSAL ( Super Large )

## School OPP BAG Super large

- **Reference:** J00251
- **Size:** (4+0.3+34)\*22cm
- **Packing :** 200pcs/Package
- **G.W.:** 1.65KG
- **Logistic:** : 0.00303m<sup>3</sup>  
( package meas.: 22.5 \*27\*5cm)

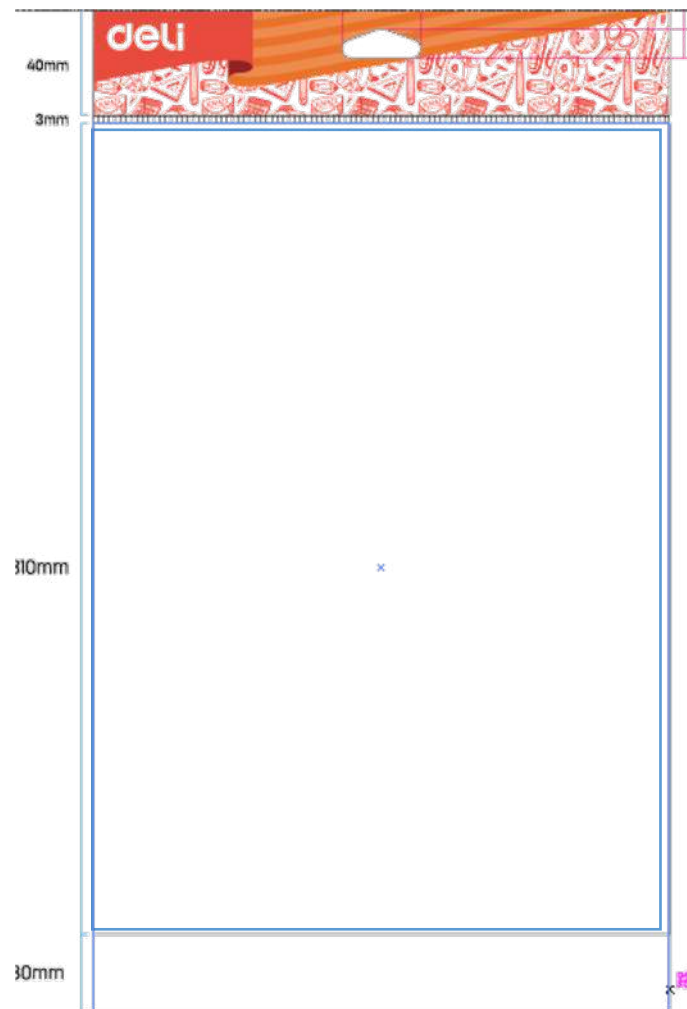



# School OPP BAG UNIVERSAL L

## School OPP BAG large

- **Reference:** J00250
- **Size:** (4+0.3+22)\*14.4cm
- **Packing :** 200pcs/Package
- **G.W.:** 0.88KG
- **Logistic:** : 0.00206m<sup>3</sup>  
( package meas.: 15\*27.5\*5cm)

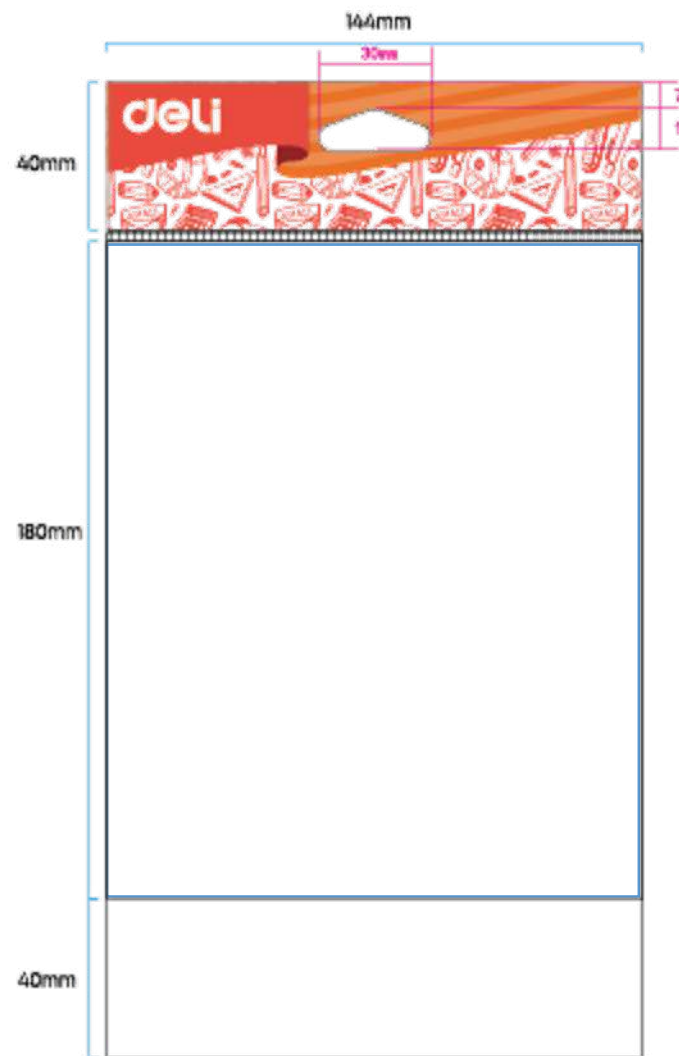

# School OPP BAG UNIVERSAL M

## School OPP BAG Middle

- **Reference:** J00249
- **Size:** (4+0.3+25)\*10.6cm
- **Packing :** 200pcs/Package
- **G.W.:** 0.74KG
- **Logistic :** 0.00167m<sup>3</sup>  
( package meas.: 11\*30.5\*5cm)

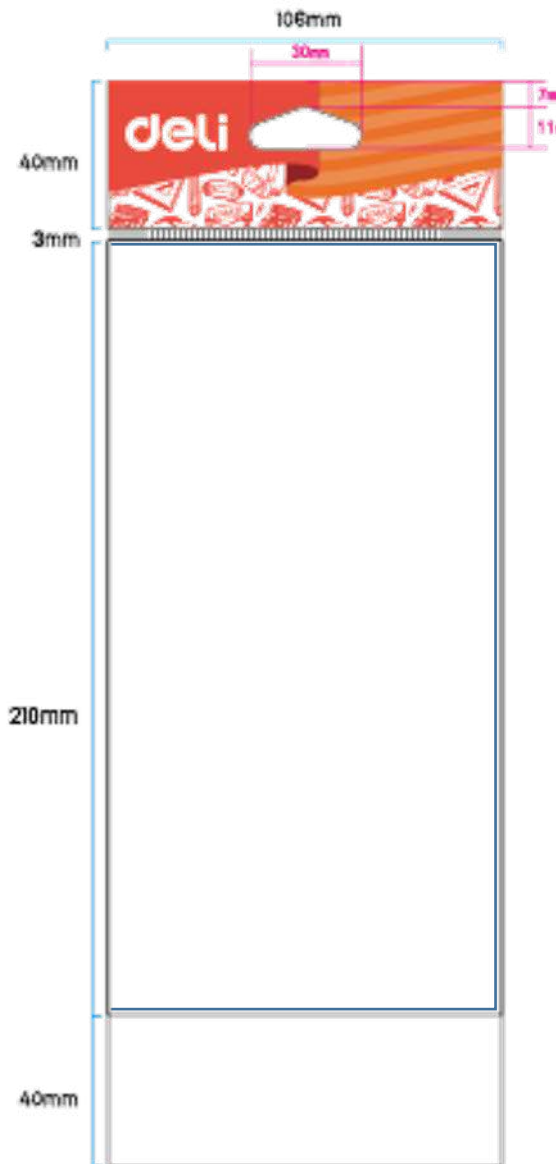

## School OPP BAG Small

- **Reference:** J00248
- **Size:** (4+0.3+22)\*8.4cm
- **Packing :** 200pcs/Package
- **G.W.:** 0.52KG
- **Logistic :** 0.00123m<sup>3</sup>  
( package meas.: 9\*27.5\*5cm)

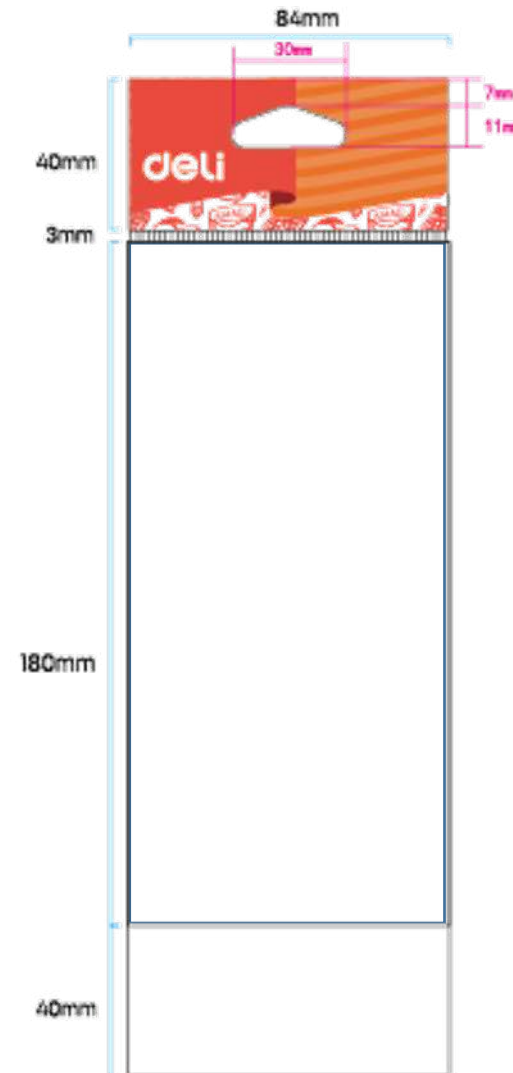

# School OPP BAG UNIVERSAL Mini

## School OPP BAG Mini

- **Reference:**J00252
- **Size:**  $(4+0.3+20)*4.5\text{cm}$
- **Packing :** 200pcs/Package
- **G.W.:** 0.25KG
- **Logistic:** : 0.00066m<sup>3</sup>  
( package meas.: 5\*26.6\*5cm)

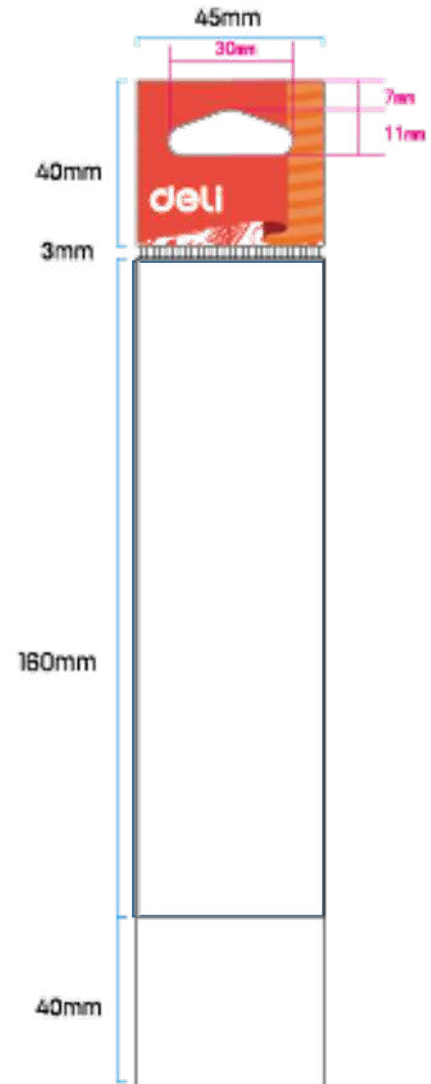

# School Metal Floor Display

## ■ School Metal Floor Display

### ■ Reference: J00191

- Size : 200cm x 40cm x 60cm.
- Number of hooks : 40 without label holder
- Number of shelves : 2 can be removed
- Material : Steel Metal
- Marking

*Silk screening on base.*

*Printed KT-board on sides ( can be replaced )*

*Printed soft PP board on banner ( can be replaced )*

- Logistic : 0.15m<sup>3</sup> ( 2 box of 0.076m<sup>3</sup> & 0.073m<sup>3</sup> )
- N.W.:18.7 KG
- G.W.:22.56 KG
- Palletized



# 1.5M School Metal Display

## ■ 1.5M School Metal Display

■ **Reference: J00194**

■ Size : 40\*50\*150cm.

■ Number of hooks : 20 without label holder

■ Number of shelves : 2 can be removed

■ Material : Steel Metal

■ Marking

*Printed KT-board on side ( can be replaced )*

■ Logistic : 0.16m<sup>3</sup> ( 2 box of 0.12m<sup>3</sup> & 0.04m<sup>3</sup> )

■ N.W.:16.6 KG

■ G.W.:18.9 KG



# School Transversal Display

## ■ School KT-board Floor Display

### ■ Reference: 00224-3

- Size : 155cm x 60cm x 40cm.
- Construction: 2 layers
- Hooks: 12 plastic hooks (13cm)
- Material: PVC board
- Logistic: 0.32m<sup>3</sup> ( box meas.: 87.3\*55.5\*66.5 cm)
- Packing: 1 PCS / CASE
- N.W.: 7.8 KG
- G.W.: 10.4 KG



# BUMPEES BALLOON SET

## ■ Bumpees Balloon Set

■ **Reference: J00197**

■ Size : 45cm\*45cm.

■ Material: Aluminum Filmed

■ Logistic:0.002m<sup>3</sup>( box meas.: 28\*50\*1.5 cm)

■ Packing: 50 Pcs/ Package

■ G.W.: 0.5 KG



---

## ■ **Reference: J00204**

■ Size : 7.8cm\*44cm

■ Color: Yellow/Blue/Green/Pink (Random Color)

■ Material: PP

■ Logistic:0.02m<sup>3</sup>( box meas.: 25\*18\*43 cm)

■ Packing: 50 Pcs/ Package

■ G.W.: 1.36 KG



**One Package Include 50  
Pcs Balloon and 50 Pcs  
Base**



deli

## BUMPEES CARTOON BOARD

Size :

HOLIDAY (BIG): 120cm\*89.5cm

SPACE (BIG): 120cm\*88cm

GRASS (BIG): 120cm\*93cm

BLUE: 55cm\*34cm

PURPLE: 56cm\*41cm

RED: 42cm\*35cm

YELLOW: 48cm\*45cm

Material: KT Board

(Double-sided printing)



**Stock Temporary**

deli

# BUMPEES COLORING BOOK

- **Reference: J00198**
- Size : 21.5x21.5cm
- Pages: 12 Pages
- Logistic:0.02m<sup>3</sup> (box means: 43x22.5x24cm)
- Packing:200 Pcs/ Case
- N.W.: 15.5 kgs
- G.W.: 16 kgs

Please inform us in advance if the quantity exceeds 1000 PCS

**Bumpees**

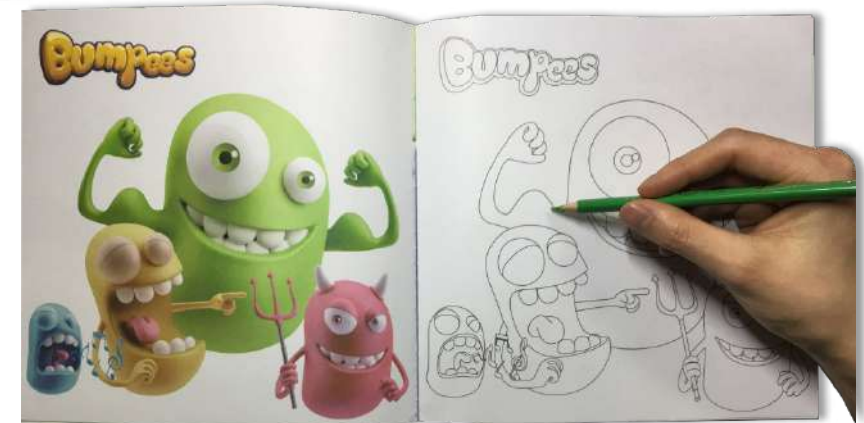
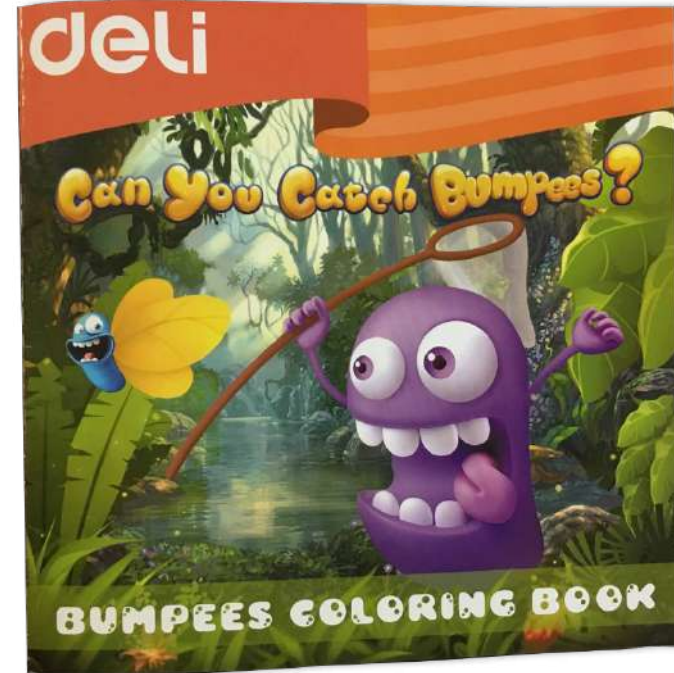

# BUMPEES METAL FLOOR DISPLAY

- **Reference: J00195**
- Size : 43\*50\*150cm
- Number of hooks : 6 without label holder
- Number of shelves : 1 can be removed
- Material : Steel Metal
- N.W.: 17.5 KG
- G.W.: 19.8 KG
- Logistic : 0.18m<sup>3</sup> ( 2 box of 0.05m<sup>3</sup> & 0.13m<sup>3</sup> )

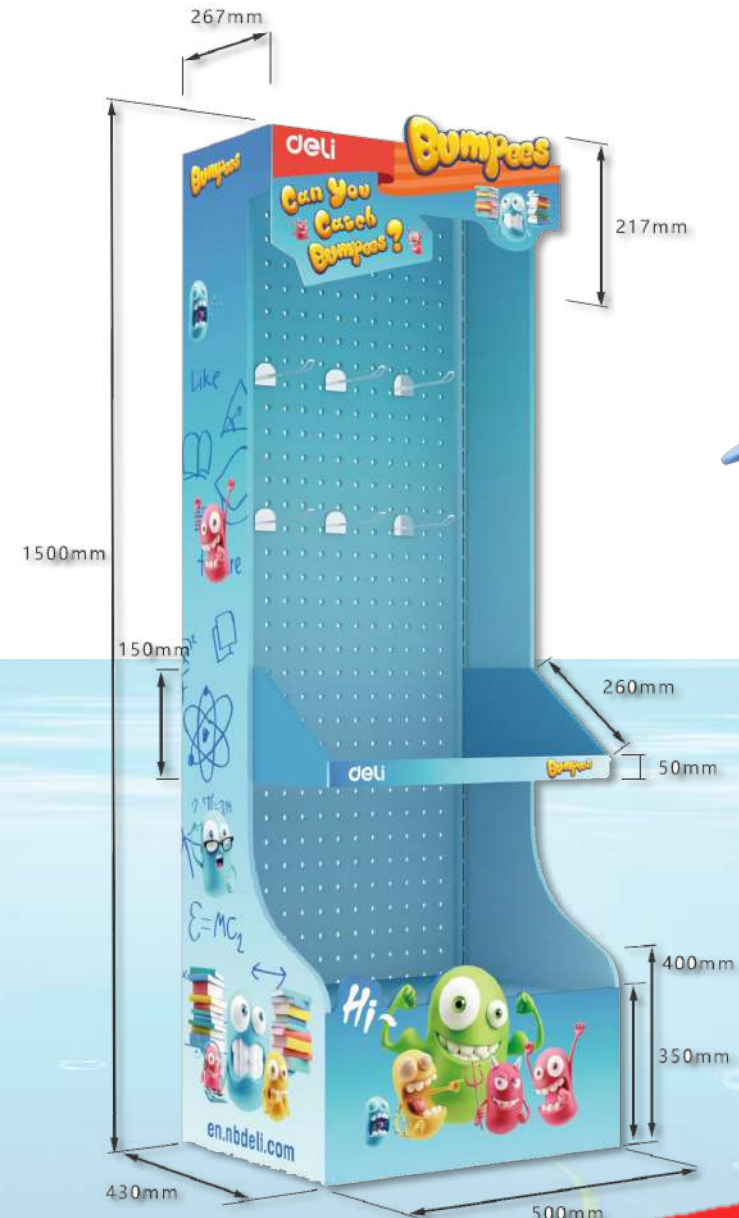

deli

# BUMPEES FLOOR DISPLAY



- **Reference: J00331**
- Size : 56\*28\*155cm
- Material: paper
- Logistic:157\*61.5\*13cm
- Packing: 2pcs
- G.W.: 6.5kg



**Bumpees**

deli



# DOUGHT IT COUNTER DISPLAY

- **Reference: J00325**
- Size : 45\*25\*51cm
- Material: paper
- Logistic:56.5\*42\*9.5cm
- Packing: 5pcs
- G.W.:5kg



## Clay Tool ( suit )

- Reference: J00407
- Size : apron(64\*43);hat( $\varphi$ 26);  
oversleeve(23)cm
- Material : worsted
- Logistic : 0.11
- Packing: 1 PCS / bag
- G.W.: 0.05 kg

deli

# EXPLORA COUNTER DISPLAY



- **Reference: J00327**
- Size : 15\*35\*35cm
- Material: paper
- Logistic: 59.5\*40\*6.8cm
- Packing: 5pcs
- G.W.: 2kg



# EXPLORA FLOOR DISPLAY

- **Reference: J00328**
- Size : 20\*30\*165cm
- Material: paper
- Logistic:167.5\*74\*9cm
- Packing: 2pcs
- G.W.:6.21kg
- **Capacity**  
**2 shelf lines**  
**3 lines of hooks**



deli

# EXPLORA STICKER PAD

- **Reference: J00329**
- Size : 35 × 25cm
- Material: paper
- Logistic: 0.0288m<sup>3</sup>(34.5\*31\*27cm)
- Packing: 50 pcs
- G.W.:19.2kg





# Super wings gift bag



- **Reference: J00508**
- Size : 300\*100\*400mm
- Material: paper
- Logistic:
- Packing: 50 pcs
- G.W.:

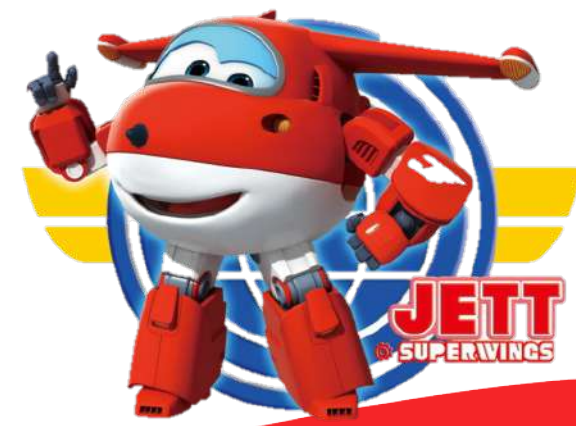



deli

**STICK  
UP**

# Клеящие

# ADHESIVE PRODUCTS CATALOGUE 2019

deli

STICK  
UP

## ADHESIVE PRODUCTS CATALOGUE 2019

- **Reference: J00379**
- Size : 18cm x 24cm
- Material: Paper
- Logistic:0.018m<sup>3</sup> ( box meas.: 32\*26\*21mm)
- Packing: 50 PCS / CASE
- N.W: 10.5 KG
- G.W: 11 KG



DELI GROUP CO., LTD.



# OPP BAG STICKUP S

deli

STICK  
UP

## Opp Bag Stickup S Specification

- **Reference: J00156A**
- Size :  $(40+3+180)*79$ mm
- Logistic:  $0.0008\text{m}^3$ ( box meas.:  $8*27*4$  cm)
- Packing: 200 PCS / Package
- G.W.:0.38 KG

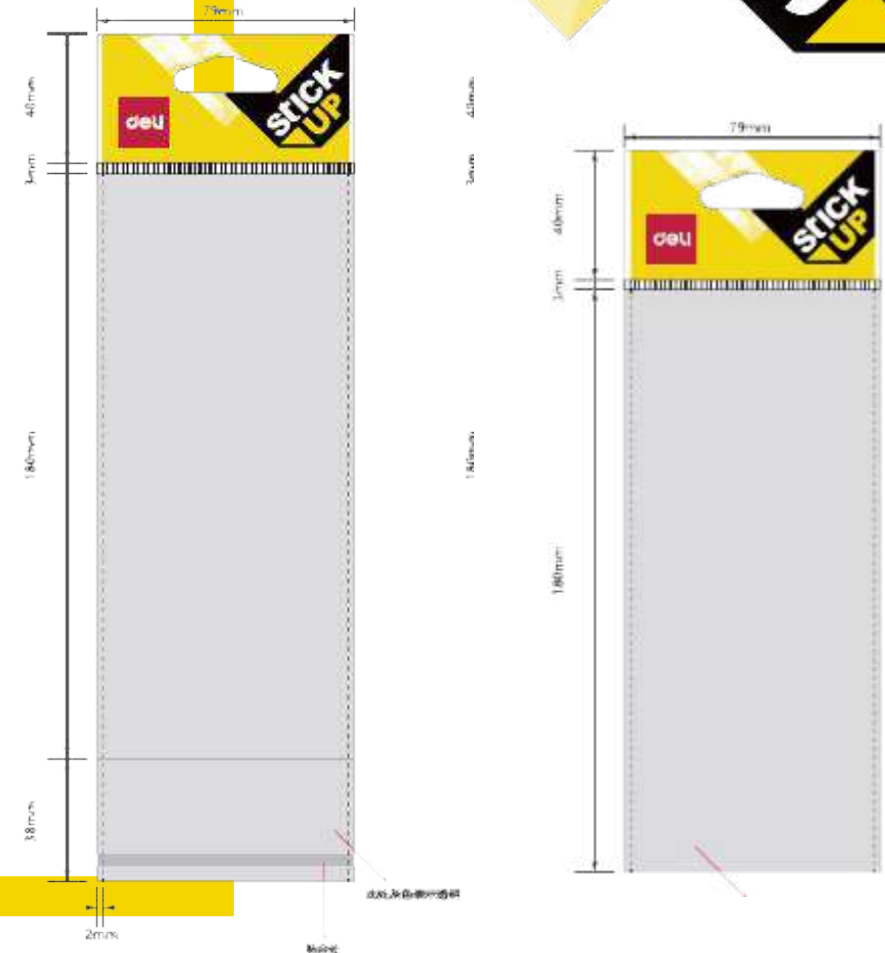

# OPP BAG STICKUP M

deli

STICK  
UP

## Opp Bag Stickup M Specification

- **Reference: J00157A**
- Size : (40+3+180)\*129mm
- Logistic: 0.0017m<sup>3</sup>( box meas.: 13\*27\*5 cm)
- Packing: 200 PCS / Package
- G.W.:0.61 KG

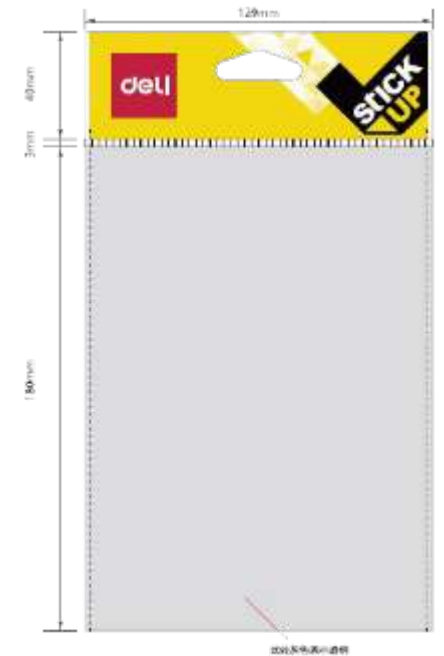

# STICK UP GLUE STICK DISPLAY

deli

STICK  
UP

## Stick Up Glue Stick Display Specification

- **Reference: 7120C**
- Size : 28cm x 20.5cm x 15cm.
- Number of shelves: 3
- Number of Glue Slots : 60 PCS
- Material :HIPS
- Logistic : 0.01m<sup>3</sup> ( box meas.: 29.5\*22\*17.5 CM)
- Packing: 1 PCS/ CASE
- N.W.: 0.41 KG
- G.W.: 0.67 KG



# STICK UP LEAFLET

deli

STICK UP

## STICK UP LEAFLET

- **Reference: J00226**
- Size :14.8 \* 21cm (Fold)  
44.2 \* 21cm (Unfold)
- Material : Art Paper 157g
- Logistic : 0.04m<sup>3</sup> ( box meas.: 45\*33\*26 CM)
- Packing:100 Pcs / Package
- G.W: 1.7 KG

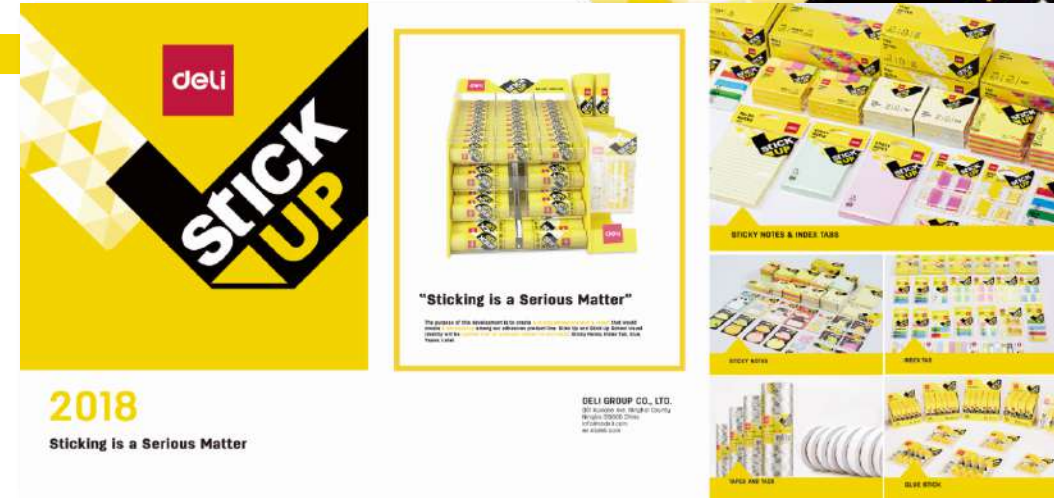



# STICK UP MENTAL FLOOR DISPLAY

deli

STICK  
UP

## STICK UP Metal Floor Display

- **Reference: J00024**
- Size : 200cm x 40cm x 60cm.
- Number of hooks : 40 without label holder
- Number of shelves : 2 can be removed
- Material : Steel Metal
- Marking

*Silk screening on base.*

*Printed KT-board on sides ( can be replaced )*

*Printed soft PP board on banner ( can be replaced )*

- Logistic : 0.15m<sup>3</sup> ( 2 box of 0.076m<sup>3</sup> & 0.073m<sup>3</sup> )
- N.W.:7.7 KG (A) 11 KG (B)
- G.W.:8.78 KG(A) 13.78 KG (B)
- Palletized



# 1.5M STICK-UP METAL DISPLAY

deli

STICK  
UP

## 1.5M STICK-UP METAL DISPLAY

- **Reference: J00193**
- Size : 40\*50\*150cm.
- Number of hooks : 20 without label holder
- Number of shelves : 2 can be removed
- Material : Steel Metal
- Marking
  - Printed KT-board on side ( can be replaced )*
- Logistic : 0.16m<sup>3</sup> ( 2 box of 0.12m<sup>3</sup> & 0.04m<sup>3</sup> )
- N.W.:16.1 KG
- G.W.:18.4 KG

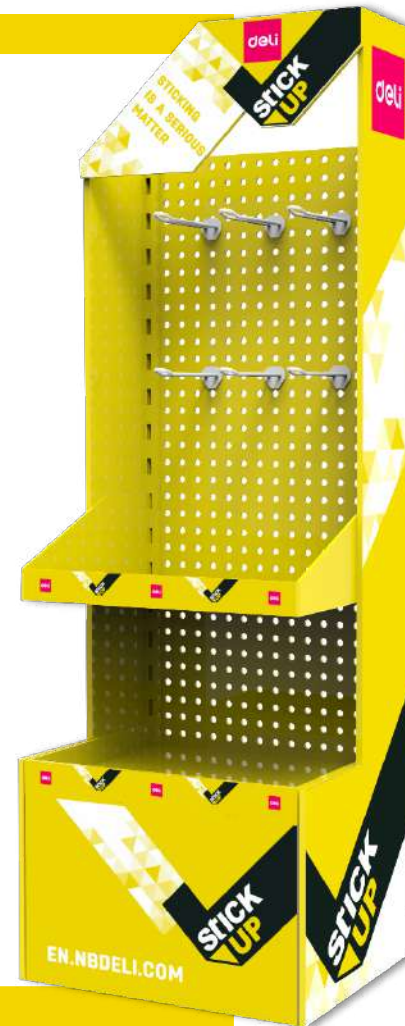

# STICK UP STICKY NOTE DISPLAY

deli

STICK  
UP

## STICK UP Sticky Note Display

- **Reference: J00062**
- Size : 32\*32\*43cm
- Number of hooks: 16 without label holder
- Material: PVC
- Logistic: 0.06m<sup>3</sup> ( box meas.: 38.5\*38.5\*41.5 cm)
- Packing: 1 PCS / CASE
- N.W.: 1.6 KG
- G.W.: 1.95 KG



# STICK UP ACRYLLC COUNTER DISPLAY

deli

STICK  
UP

## STICK UP Acrylic Counter Display

- **Reference: J00113**
- Size : 33cm x 28cm x 30cm.
- Construction: 3 layers with 8 compartments  
*Tumbling design: Replenish in the back and product falls off automatically*
- Hooks: 1 hook (13cm)
- Material: Acrylic
- Logistic: 0.06m<sup>3</sup> ( box meas.: 39.5\*38.5\*42.5cm)
- Packing: 1 PCS / CASE
- N.W.: 2.2 KG
- G.W.: 3.2 KG



Volume: accommodate 27pcs 8g-glue stick, 18pcs 15-glue stick, 20pcs 20-glue stick, 18pcs 36g-glue stick

deli

# Пишущие инструменты



deli

# WRITING TOOLS SAMPLE BAG

- **Reference: J00323**
- Size : 48\*21.2 cm
- Material : thick canvas
- Logistic :0.011m<sup>3</sup> (51\*22\*10cm)
- Packing: 20 PCS / CASE
- G.W.: 3KG
- Capacity : 26 pen holder + 5 marker holder



# WRITING INSTRUMENT SAMPLE KIT - MENA & CIS & CEE

- **Reference: J00324**
- Size : 472\*210mm
- Material : PAPER
- Logistic : 0.039m<sup>3</sup>(44\*31.5\*28cm)
- Packing: 50 PCS / CASE
- G.W: 3.3KG
- Capacity : **2 ball pen samples + product information**

**Match to EQ00920 BLACK**  
**EQ01630 BLUE**

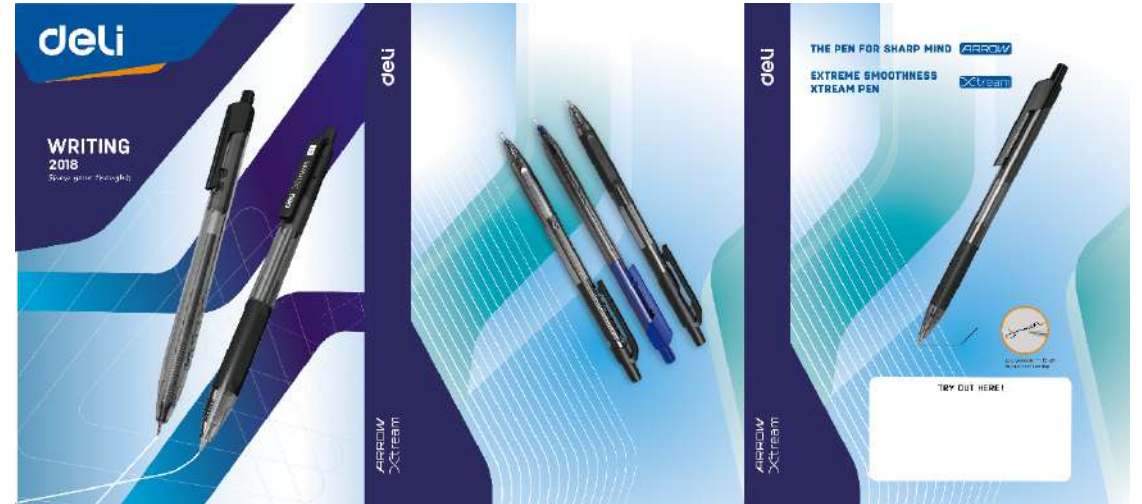

# WRITING INSTRUMENT SAMPLE KIT - SEA

- **Reference: J00335**
- Size : 472\*210mm
- Material : PAPER
- Logistic :0.039m<sup>3</sup>(44\*31.5\*28cm)
- Packing: 50 PCS / CASE
- G.W: 3.3KG
- Capacity : **2 ball pen samples + product information**

**Match to EQ01020 BLACK  
EQ01230 BLUE**





# WRITING TOOLS GENERAL COUNTER DISPLAY

- **Reference: J00318**
- Color: Blue & transparent
- Size: 32\*19.6\*(26.6+10)CM
- Packing: 1 PCS/ CASE
- G.W: 1.9kg
- Logistic : (0.021m<sup>3</sup>)



# Universal Writing Instrument OPP Bag S

## Universal Writing Instrument OPP Bag

**Reference: J00380**

- **Size:** (35+3+40+35)\*220mm
- **Packing :** 200pcs/Package
- **G.W.: 0.25KG**
- **Logistic: :** 0.00303m<sup>3</sup>  
( package meas.: 22.5 \*27\*5cm)

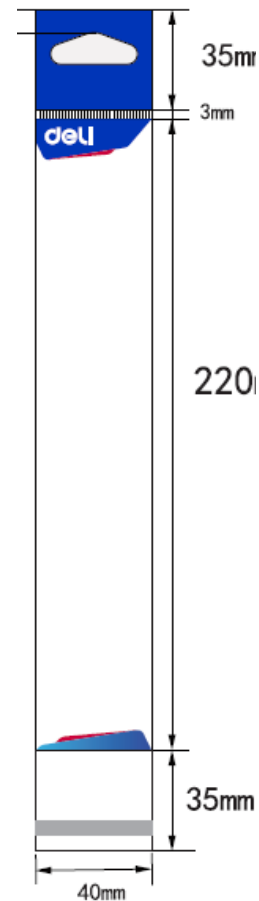

# Universal Writing Instrument OPP Bag M

## Universal Writing Instrument OPP Bag M

**Reference: J00382**

- **Size:** (35+3+65+35)\*163mm
- **Packing :** 200pcs/Package
- **G.W.: 0.38KG**
- **Logistic:** : 0.062m<sup>3</sup>(425\*395\*370MM)

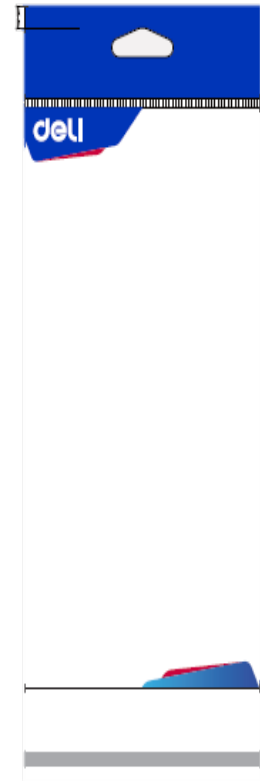

deli

# Universal Writing Instrument OPP Bag L

## Universal Writing Instrument OPP Bag L

**Reference: J00381**

- **Size:** (35+3+70+35)\*220mm
- **Packing :** 200pcs/Package
- **G.W.:** 0.61KG
- **Logistic:** : 0.047m<sup>3</sup>(450\*350\*300MM)

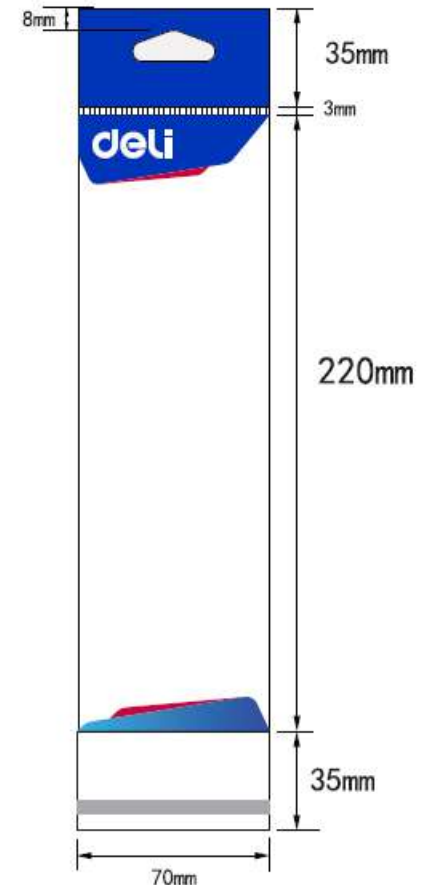

deli

# Universal Writing Instrument OPP Bag XL

## Universal Writing Instrument OPP Bag XL

**Reference: J00383**

- **Size:** (35+3+105+35)\*163mm
- **Packing :** 200pcs/Package
- **G.W.: 0.71KG**
- **Logistic:** 0.0341m<sup>3</sup>(440\*235\*330MM)

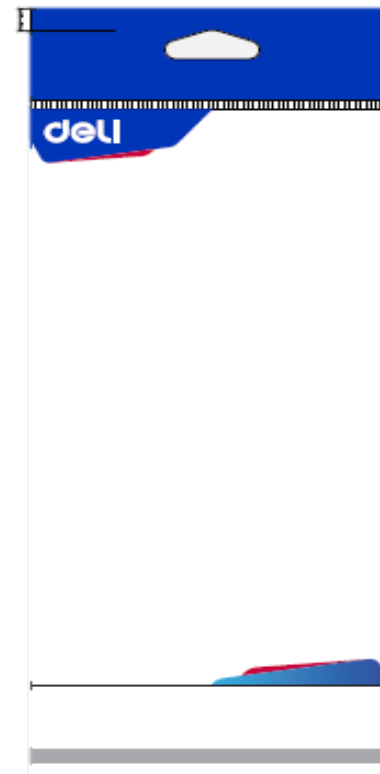

# Материалы для мероприятий



# Calculator Stand

## Calculator Stand Specification

- **Reference: W00208**
- Logistic : 0.09m<sup>3</sup> ( box meas.: 60.5\*32.5\*48 cm)
- Packing: 60 PCS/ CASE INNER  
480 PCS/ MASTER CARTON
- N.W.:12 KG
- G.W.:14.5 KG

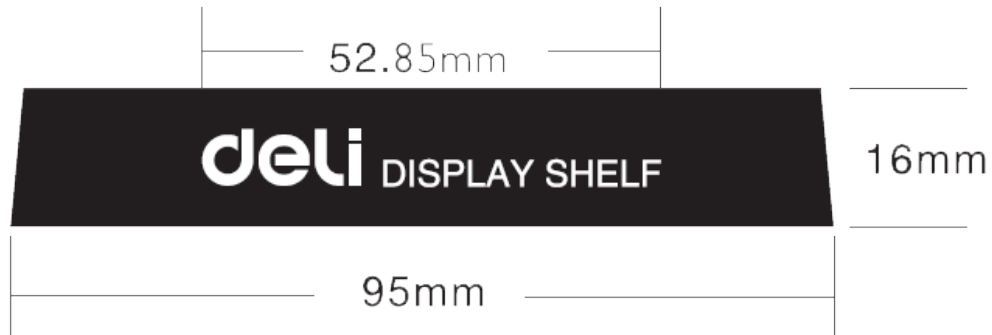

# Black Desktop Display Stand



## ■ Black Desktop Display Stand Specification

- **Reference: J00354**
- Size : 40cm\*40cm\*33cm
- Material :Acrylic
- Logistic : 0.09m<sup>3</sup> ( box meas.: 45.5\*23\*21.5 cm)
- Packing:5 PCS / CASE
- N.W.:9 KG
- G.W.:10 KG





# T-shape Acrylic Card (Vertical Type)

**deli**  
OFFICE

## ■ T-shape Acrylic Card (Vertical Type) Specification

- **Reference: J00041**
- Size : 15cm\*5cm\*22cm  
(Content): 14.8cm\*21cm
- Material :Acrylic
- Logistic : 0.01<sup>3</sup> ( box meas.: 26.5\*19\*17 cm)
- Packing: 10 PCS/ CASE
- N.W: 2.5 kg
- G.W: 3 kg



# T-shape Acrylic Card (Horizontal Type) **deli** OFFICE

## ■ T-shape Acrylic Card (Horizontal Type) Specification



- **Reference: J00042**
- Size : 21cm\*5cm\*16cm  
(Content): 21cm\*14.8cm
- Material :Acrylic
- Logistic : 0.008<sup>3</sup> ( box meas.: 19\*19\*22.5 cm)
- Packing: 10 PCS/ CASE
- N.W: 2.5 kg
- G.W: 3 kg



# U-shape Acrylic Shelf

## ■ U-shape Acrylic Shelf Specification

- **Reference: J000352**
- Size : 40cm\*40cm\*12.5cm ( Top: 35cm\*35cm)
- Material : PS board
- Logistic : 0.08m<sup>3</sup> ( box meas.: 31\*25\*16 cm)
- Packing: 8 PCS / CASE
- N.W.: 8 KG
- G.W.: 9 KG

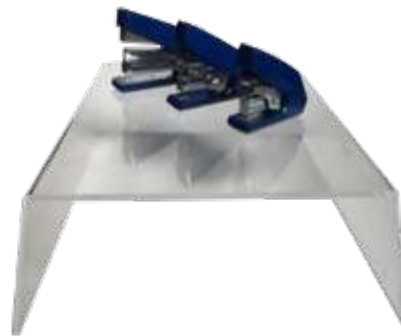

# Slope Type Acrylic Shelf

## ■ Slope Type Acrylic Shelf Specification

- **Reference: J00353**
- Size : 55cm\*34cm\*21cm
- Material : PS board
- Logistic : 0.06m<sup>3</sup> ( box meas.: 49\*24\*44.5 cm)
- Packing:4 PCS / CASE
- N.W.:5 kg
- G.W.:6 kg



# Student Gel Pen Tray

## ■ Student Gel Pen Tray Specification



- **Reference: J00350**
- Size : 35.6cm\*14.5cm\*9cm
- Material :Acrylic
- Number of Pen Slot: 12
- Logistic : 0.04m<sup>3</sup> ( box meas.: 44.5\*20\*45 cm)
- Packing:15 PCS / CASE
- G.W.:6 kg

# Summit paper



## ■ Summit paper

- **Reference: J00358**
- Size : 21\*28.5cm
- Material : paper
- Logistic : 0.0091m<sup>3</sup> ( box meas.: 21\*29\*15 cm)
- Packing: 100PCS / CASE (30 sheets)
- G.W.: 7.2 kg

# New product sticker



## ■ New product sticker

- **Reference: J00362**
- Size : 5\*5cm
- Material : paper
- Logistic : 0.019m<sup>3</sup> ( box meas.: 26.5\*7.7cm)
- Packing: 100PCS / CASE
- G.W.: 0.05 kg

# Top Sale Sticker



## ■ Top Sale Sticker

- **Reference: J00363**
- Size : 5\*5cm
- Material : paper
- Logistic : 0.019m<sup>3</sup> ( box meas.: 26.5\*7.7cm)
- Packing: 100PCS / CASE
- G.W.: 0.05 kg



# Price Sticker

## ■ Price Sticker



**deli**

**Name:** \_\_\_\_\_

**REF:** \_\_\_\_\_

**Spec:** \_\_\_\_\_

**Package:** \_\_\_\_\_

**Price:** \_\_\_\_\_

- **Reference: J00364**
- Size : 7.84\*5.48cm
- Material : paper
- Logistic : 0.011m<sup>3</sup> ( box meas.: 16\*7.7cm)
- Packing: 100PCS / CASE
- G.W.: 0.16 kg

# Deli Emblem

## ■ Deli Emblem

- **Reference: J00366**
- Size : 2\*2cm
- Material : metal
- Logistic : 0.011m<sup>3</sup> ( box meas.: 16\*7.7cm)
- Packing: 100PCS / CASE
- G.W.: 0.57 kg



# Event Cube



## ■ Event Cube

- **Reference: J00370**
- Size : (deli) 80\*80\*80 (welcome) 40\*40\*40
- Material : ivory board
- Logistic : 0.13m<sup>3</sup>
- Packing: 3PCS / CASE
- G.W.: 6.87 kg

# Lottery Box



## ■ Lottery Box

- **Reference: J00369**
- Size : 30\*30\*30
- Material : ivory board
- Logistic : 0.150m<sup>3</sup>
- Packing: 1 PCS / CASE
- G.W.: 0.48 kg

# Container



## ■ Container

- **Reference: J00359**
- Size : 60 × 38 × 31 cm
- Material : plastic
- Logistic :60\*50\*96cm
- Packing: 8 PCS / CASE
- G.W.: 27kg

# Standing display

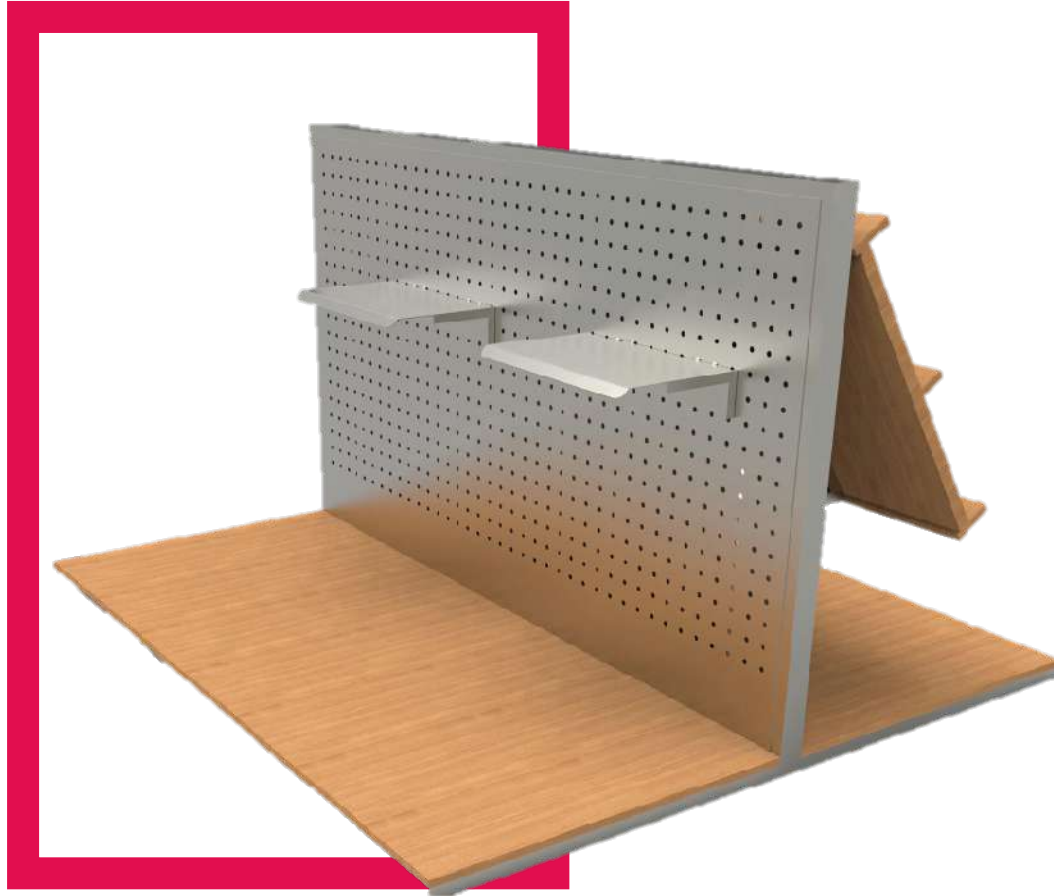

## ■ Standing display

- **Reference: J00509**
- Size : 1000\*900\*600mm
- Material : Metal
- Logistic :104\*16\*66cm
- Packing: 2 PCS / CASE
- G.W: 33.2 kg

**on-demand**

# Shelf board

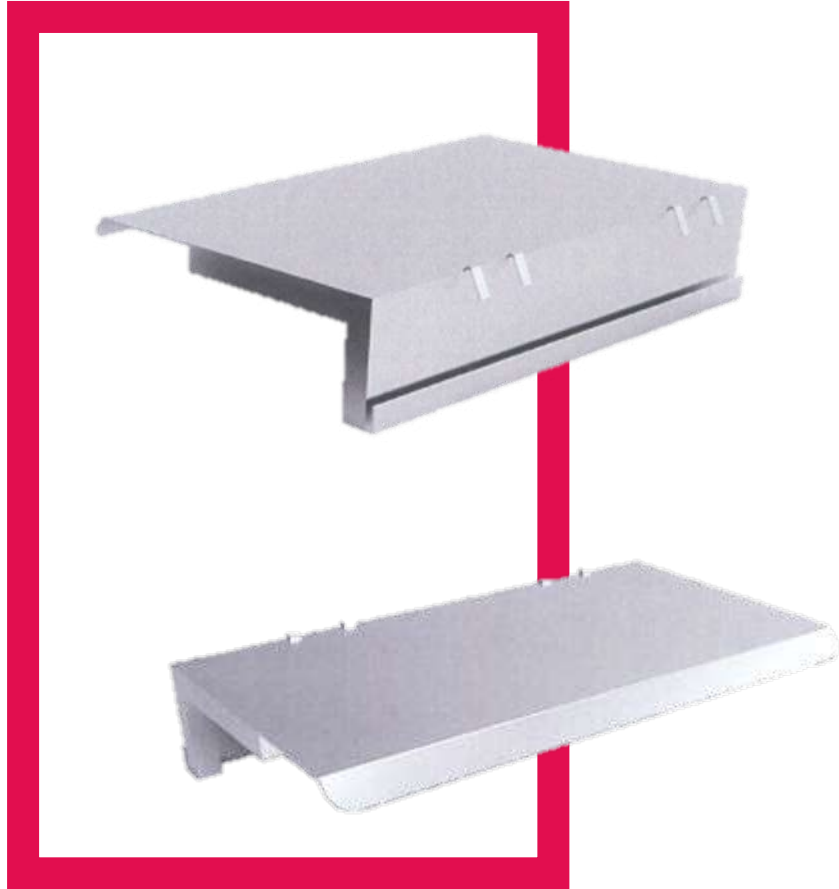

## ■ Shelf board of standing display

- **Reference: J00512**
- Size : 246\*158\*50mm
- Material : Metal
- Logistic : 27\*16\*25cm
- Packing: 8 PCS / CASE
- G.W: 4.2 kg

**on-demand**

# Poster hold

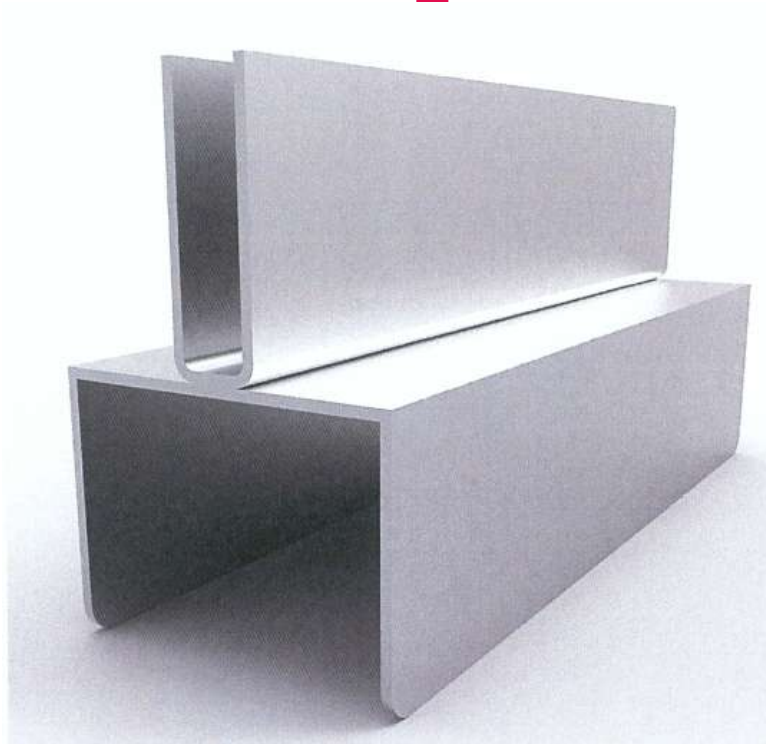

## ■ Poster hold of standing display

- **Reference: J00513**
- Size : 100\*33\*44 mm
- Material : Metal
- Logistic : 15\*5\*11cm
- Packing: 10 PCS / CASE
- G.W: 1.3 kg

**on-demand**



# Acrylic poster clamp



## ■ Acrylic poster clamp of standing display

- **Reference: J00514**
- Size : 700\*4\*150 mm
- Material : Acrylic
- Logistic : 71\*8.5\*16cm
- Packing: 10 PCS / CASE
- G.W.: 5.8 kg

**on-demand**

# Acrylic attendance machine display



## ■ Acrylic attendance machine display

- **Reference: J00517**
- Size : 107\*80\*175mm
- Material : Acrylic
- Logistic : 0.038m<sup>3</sup>
- Packing: 8 PCS / CASE
- G.W.: 3 kg

**on-demand**



# Scanner display



## ■ Scanner display

- **Reference: J00518**
- Size: 100\*90\*180mm
- Logistic : 44\*36\*24cm
- Packing: 8
- N.W.:2 KG
- G.W.:3 KG

**on-demand**

# Pen tray

## ■ Calculator Stand Specification

- **Reference: J00510**
- Size: 997\*50\*387mm
- Logistic : 104.5\*16.5\*44cm
- Packing: 3
- N.W.:16.8 ± 0.5KG
- G.W.:17.9 ± 0.5 KG

**on-demand**

